

Miniature Switches and Pilot lights

Ø12 A2 Series

Ø10 A1 Series

Ø8 A8 Series



A2 Series



A1 Series





A8 Series

Bright illumination face and snap-action switching.



• See website for details on approvals and standards.

Hole Size	Model	Function	Degree of Protection
Ø12	 AL2	Illuminated Pushbuttons Momentary Maintained Pilot Light	IP65 IP40 (IEC60529)
	 AB2	Pushbuttons Momentary Maintained	
Ø10	 AL1	Illuminated Pushbuttons Momentary Maintained Pilot Light	IP40 (IEC60529)
	 AB1	Pushbuttons Momentary Maintained	
Ø8	 AL8	Illuminated Pushbuttons Momentary Maintained Pilot Light	IP40 (IEC60529)
	 AB8	Pushbuttons Momentary Maintained	

ø12 A2 / ø10 A1 / ø8 A8 Series Miniature Pilot Lights

Bright illumination face and snap-action switching. 22 mm short body.

Contact Ratings (Contact Block)

Rated Insulation Voltage	250V			
Rated Thermal Current	3A			
Operating Voltage (AC/DC)	24V	110V	220V	
AC 50/60 Hz	Resistive Load	—	1.0A	0.5A
	Inductive Load	—	0.7A	0.5A
DC	Resistive Load	1.0A	0.2A	—
	Inductive Load	0.7A	0.1A	—
Contact Material	Silver			

- Minimum applicable load: 5V AC/DC, 3 mA
(applicable range may vary with operating conditions and load types)

Weight (Example)

Weight (approx.)	A2 Series	4g (AL2M-M11, AL2M-P1, AB2M-M1)
	A1 Series	3g (AL1M-M11, AL1M-P1, AB1M-M1)
	A8 Series	2g (AL8M-M11, AL8M-P1, AB8M-M1)

Specifications

Operating Temperature	-25 to +55°C (no freezing)	
Storage Temperature	-30 to +80°C (no freezing)	
Operating Humidity	45 to 85% RH (no condensation)	
Contact Resistance	50 mΩ maximum (initial value)	
Insulation Resistance	100 MΩ minimum (500V DC megger)	
Dielectric Strength	Switch Unit	Between live and dead metal parts: 2,000V AC, 1 minute Between terminals of different poles: 2,000V AC, 1 minute Between terminals of the same pole: 1,000V AC, 1 minute Between contact and lamp terminals: 1,500V AC, 1 minute
	Illumination Unit	Between live part and ground: 2,000V AC, 1 minute
Vibration Resistance	Damage limits, Operating extremes: 5 to 55 Hz, amplitude 0.75 mm	
Shock Resistance	Damage limits: 500 m/s ² (50G) Operating extremes: 200 m/s ² (20G)	
Mechanical Durability (minimum operations)	Momentary: 200,000 operations Maintained: 100,000 operations	
Electrical Durability (minimum operations)	Momentary: 100,000 operations Maintained: 50,000 operations (Switching frequency 1200 operations/h)	
Degree of Protection (*1)	IP40, IP65 (IEC 60529)	

*1) IP65: A2 series only

LED Lamp Ratings (LAD-S)

Built-in LED Part No.	LAD-SA	LAD-SG	LAD-SR	LAD-SY
Lamp Base	Exclusive for A series			
Forward Current (If)	20 mA			
Forward Voltage (Vf) (nominal)	2.2V	2.1V	1.7V	2.2V
Reverse Voltage (Vr)	4V			
Illumination Color	A	G	R	Y
LED Lamp Color	Amber Clear	Yellow Diffused	Red Clear	Yellow Clear
Applicable Lens Color	Amber	Green	Red	Yellow and White
Base Plastic Color	Red			
LED Lamp Life (reference value)	Approx. 50,000 hours (The illuminance reduces to 50% of the initial intensity when used on complete DC.)			
Operating Voltage & External Current-limiting Resistor (recommended value) (Note)	5V DC: 150Ω, 1/2W 6V DC: 200Ω, 1/2W 12V DC: 510Ω, 1W 24V DC: 1.1 kΩ, 1W			
Internal Circuit				

Note: When LED lamps are used on voltages other than the above, external resistor value R is determined by the following formula:

$$R = (\text{operating voltage} - V_f) / I_f$$

- LED lamps do not have a current-limiting resistor, and external resistors of recommended values for each voltage must be provided. Connect a current-limiting resistor in series, otherwise LED lamps will be damaged. Because no protection diode is contained, ensure the correct polarity is observed.
- The base plastic color for all LEDs are red.

APEM

Switches & Pilot Lights

Control Boxes

Emergency Stop Switches

Enabling Switches

Safety Products

Explosion Proof

Terminal Blocks

Relays & Sockets

Circuit Protectors

Power Supplies

LED Illumination

Controllers

Operator Interfaces

Sensors

AUTO-ID

Flush Silhouette

ø16

ø22

ø30

Miniature

Pilot Lights

HW1Z

AP22



A Series

LD6A



ø12 A2 Series Illuminated Pushbuttons & Pilot Lights

Package Quantity: 1

Shape	Operation	Contact	Part No.		② Lens Color Code	LED Lamp
			IP40	IP65		Part No., Rated Current (External Resistor Recommended Value)
Round AL2M 	Momentary	SPDT	AL2M-M11②	AL2M-M11P②	Specify a color code in place of ② in the Part No. A: amber G: green R: red W: white Y: yellow	A: LAD-SA G: LAD-SG R: LAD-SR W/Y: LAD-SY Rated Current: 20 mA 5V DC: 150Ω, 1/2W 6V DC: 200Ω, 1/2W 12V DC: 510Ω, 1W 24V DC: 1.1 kΩ, 1W
		DPDT	AL2M-M21②	AL2M-M21P②		
	Maintained	SPDT	AL2M-A11②	AL2M-A11P②		
		DPDT	AL2M-A21②	AL2M-A21P②		
	Pilot Light	—	AL2M-P1②	AL2M-P1P②		
	Square AL2Q 	Momentary	SPDT	AL2Q-M11②		
DPDT			AL2Q-M21②	AL2Q-M21P②		
Maintained		SPDT	AL2Q-A11②	AL2Q-A11P②		
		DPDT	AL2Q-A21②	AL2Q-A21P②		
Pilot Light		—	AL2Q-P1②	AL2Q-P1P②		
Rectangular AL2H 		Momentary	SPDT	AL2H-M11②	AL2H-M11P②	
	DPDT		AL2H-M21②	AL2H-M21P②		
	Maintained	SPDT	AL2H-A11②	AL2H-A11P②		
		DPDT	AL2H-A21②	AL2H-A21P②		
	Pilot Light	—	AL2H-P1②	AL2H-P1P②		

- LED lamps do not have a current-limiting resistor. Connect a current-limiting resistor in series, otherwise LED lamps will be damaged.
- External current-limiting resistor is not necessary when an optional socket with built-in resistor is used (see B-383).
- AP2M series pilot lights (round bezel only) with built-in current-limiting resistors are also available.
- Pilot lights are not CCC certified.

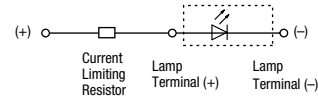

Dimensions

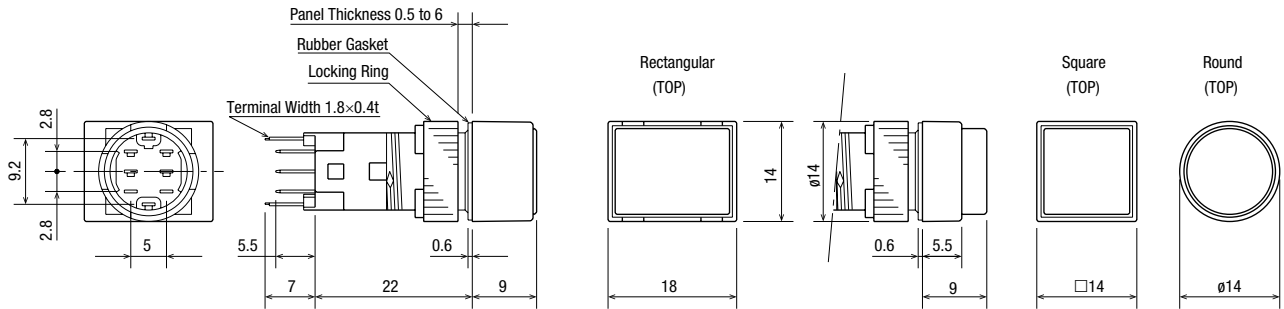

Terminal Arrangement

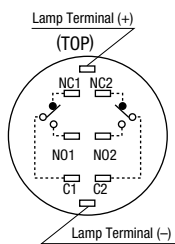

SPDT has NC1, NO1, and C1 only.

Mounting Hole Layout

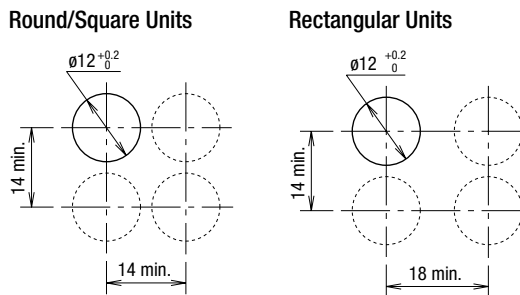



Note: Determine mounting centers to ensure easy operation.

All dimensions in mm.

ø12 A2 Series Pushbuttons

Package Quantity: 1

Shape	Button Style	Operation	Contact	Part No.		Color Code ①②
				IP40	IP65	
Round AB2M 	Button	Momentary	SPDT	AB2M-M1①	AB2M-M1P①	B: black G: green R: red S: blue W: white Y: yellow
			DPDT	AB2M-M2①	AB2M-M2P①	
		Maintained	SPDT	AB2M-A1①	AB2M-A1P①	
			DPDT	AB2M-A2①	AB2M-A2P①	
	Lens	Momentary	SPDT	AB2M-M1L②	AB2M-M1PL②	
			DPDT	AB2M-M2L②	AB2M-M2PL②	
		Maintained	SPDT	AB2M-A1L②	AB2M-A1PL②	
			DPDT	AB2M-A2L②	AB2M-A2PL②	
Square AB2Q 	Button	Momentary	SPDT	AB2Q-M1①	AB2Q-M1P①	B: black G: green R: red S: blue W: white Y: yellow
			DPDT	AB2Q-M2①	AB2Q-M2P①	
		Maintained	SPDT	AB2Q-A1①	AB2Q-A1P①	
			DPDT	AB2Q-A2①	AB2Q-A2P①	
	Lens	Momentary	SPDT	AB2Q-M1L②	AB2Q-M1PL②	
			DPDT	AB2Q-M2L②	AB2Q-M2PL②	
		Maintained	SPDT	AB2Q-A1L②	AB2Q-A1PL②	
			DPDT	AB2Q-A2L②	AB2Q-A2PL②	
Rectangular AB2H 	Button	Momentary	SPDT	AB2H-M1①	AB2H-M1P①	B: black G: green R: red S: blue W: white Y: yellow
			DPDT	AB2H-M2①	AB2H-M2P①	
		Maintained	SPDT	AB2H-A1①	AB2H-A1P①	
			DPDT	AB2H-A2①	AB2H-A2P①	
	Lens	Momentary	SPDT	AB2H-M1L②	AB2H-M1PL②	
			DPDT	AB2H-M2L②	AB2H-M2PL②	
		Maintained	SPDT	AB2H-A1L②	AB2H-A1PL②	
			DPDT	AB2H-A2L②	AB2H-A2PL②	

• Specify a color code in place of ① or ② in the Part No.

Dimensions

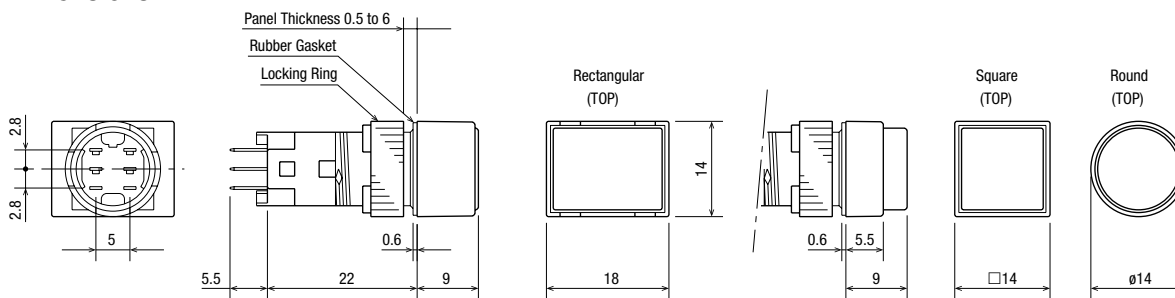

Terminal Arrangement

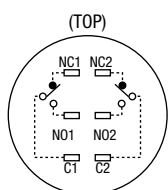

SPDT has NC1, NO1, and C1 only.

Mounting Hole Layout

Round/Square Units

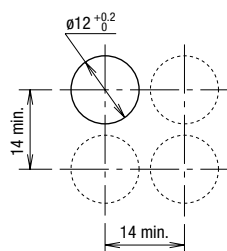

Rectangular Units

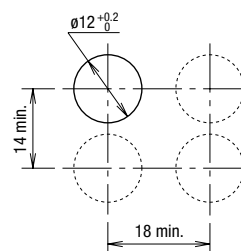

Note: Determine mounting centers to ensure easy operation.

All dimensions in mm.

- APEM
- Switches & Pilot Lights
- Control Boxes
- Emergency Stop Switches
- Enabling Switches
- Safety Products
- Explosion Proof
- Terminal Blocks
- Relays & Sockets
- Circuit Protectors
- Power Supplies
- LED Illumination
- Controllers
- Operator Interfaces
- Sensors
- AUTO-ID
- Flush Silhouette
- ø16
- ø22
- ø30
- Miniature
- Pilot Lights
- HW1Z
- AP22
- A Series
- LD6A

ø12 A2 Series Accessories

All dimensions in mm.

Shape	Material	Part No.	Ordering Part No.	Package Quantity	Remarks		
 <p>Locking Ring Wrench</p>	Metal (nickel-plated brass)	MT-002	MT-002	1	<ul style="list-style-type: none"> Used to tighten the locking ring when installing the A2 series into a panel. 		
 <p>Switch Guard</p>	90° open	For round/square unit AL-K2	AL-K2	1	<ul style="list-style-type: none"> Degree of protection: IP40 Used to protect pushbuttons from inadvertent operation. See B-384 for dimensions.  (remains 90° open)		
		For rectangular unit AL-KH2	AL-KH2	1			
 <p>Socket</p>	Solder Terminal	AL-C2	AL-C2	1	<ul style="list-style-type: none"> Snaps on the rear of the A2 series. (see B-384 for dimensions) 		
	PC Board Terminal	AL-C2V	AL-C2V	1			
 <p>Socket with Built-in Resistor</p>	Solder Terminal	5V DC	AL-C21	AL-C21	1	Socket Bottom Color <ul style="list-style-type: none"> Blue Green Yellow Red <ul style="list-style-type: none"> A current limiting resistor is contained, eliminating the need for external resistors. When using the socket with a built-in resistor, make sure that the continuous current is 1A maximum and the operating temperature is -25 to +40°C. In collective mounting, keep center-to-center-spacing of 20 mm or more between adjacent units in consideration of built-in resistor heating. See B-384 for dimensions. 	
		6V DC	AL-C22	AL-C22	1		
		12V DC	AL-C23	AL-C23	1		
		24V DC	AL-C24	AL-C24	1		
		PC Board Terminal	5V DC	AL-C21V	AL-C21V		1
			6V DC	AL-C22V	AL-C22V		1
			12V DC	AL-C23V	AL-C23V		1
			24V DC	AL-C24V	AL-C24V		1
 <p>Terminal Cover</p>	Nylon	AL-V2	AL-V2PN10	10	<ul style="list-style-type: none"> When wiring the terminals, insert the lead wires into the terminal cover holes before soldering. Terminal cover is not attached and must be ordered separately. 		
 <p>Dust Cover</p>	① For round units	AL-D2	AL-D2	1	<ul style="list-style-type: none"> When mounting the units with the dust covers installed, refer to mounting hole layout on B-384. Operating temperature: -10 to +55°C Material Front part: Elastomer (transparent) Rear part: Polypropylene (black) See B-384 for dimensions and mounting hole layout. 		
	② For square units	AL-DQ2	AL-DQ2	1			
	③ For rectangular units	AL-DH2	AL-DH2	1			
 <p>Mounting Hole Plug</p>	Nitril rubber (black)	AL-B2	AL-B2PN05	5	<ul style="list-style-type: none"> Degree of protection: IP65 		

- APEM
- Switches & Pilot Lights
- Control Boxes
- Emergency Stop Switches
- Enabling Switches
- Safety Products
- Explosion Proof
- Terminal Blocks
- Relays & Sockets
- Circuit Protectors
- Power Supplies
- LED Illumination
- Controllers
- Operator Interfaces
- Sensors
- AUTO-ID

- Flush Silhouette
- ø16
- ø22
- ø30
- Miniature
- Pilot Lights

- HW1Z
- AP22
- A Series
- LD6A

ø12 A2 Series Dimensions

All dimensions in mm.

Switch Guard

For Round/Square Units (AL-K2)

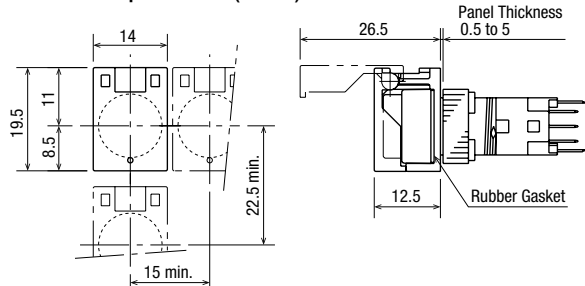

For Rectangular Units (AL-KH2)

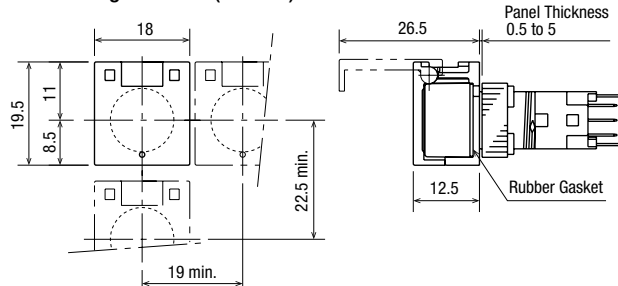

Socket

(AL-C2, AL-C2V, AL-C2□)

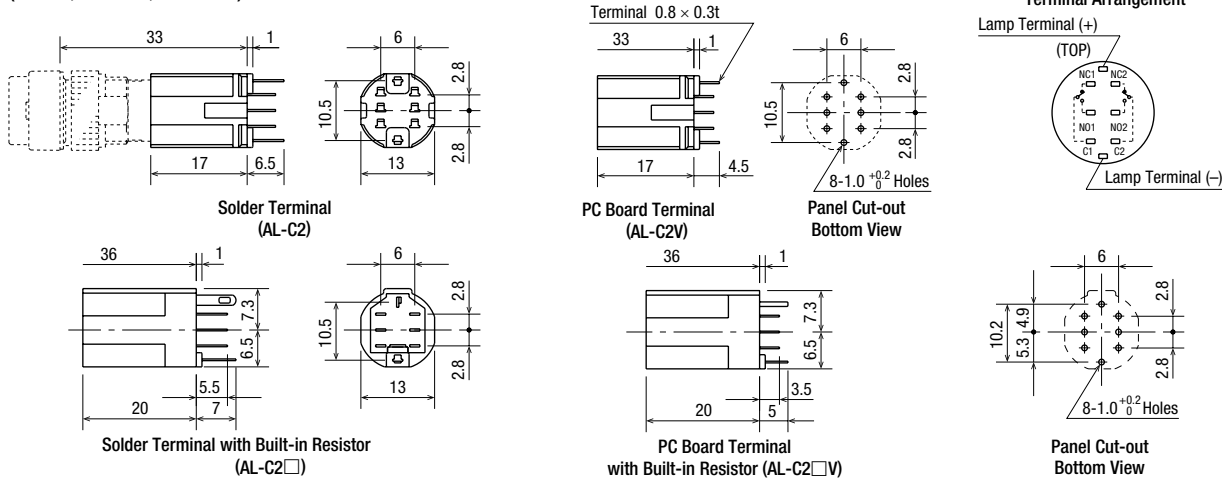

Terminal Cover

(AL-V2)

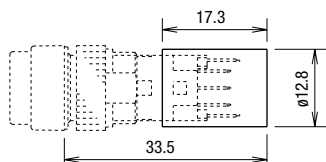

Note: When wiring the terminals, insert the lead wires into the terminal cover holes before soldering.

Dust Cover

For Round Units (AL-D2)

For Square Units (AL-DQ2)

For Rectangular Units (AL-DH2)

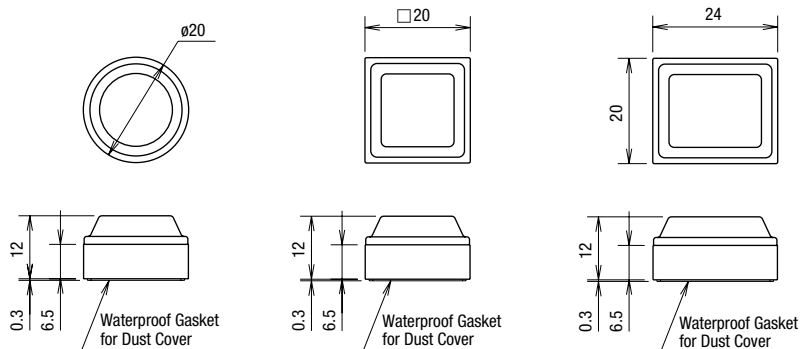

Mounting Hole Centers (Round Units, Square Units)

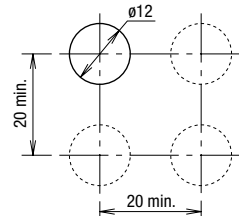



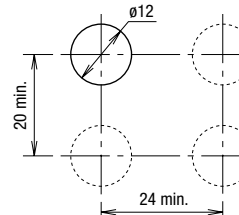



(Rectangular Units)



Note: Determine mounting centers to ensure easy operation.



ø12 A2 Series Maintenance Parts

All dimensions in mm.

Shape	Specification		Part No.	Ordering Part No.	Package Quantity	Color Code ①②
	Round		AL2M-W	AL2M-WPN05	5	White
	Square		AL2Q-W	AL2Q-WPN05		
	Rectangular		AL2H-W	AL2H-WPN05		
	For IP40 units	Round	AL2M-LK1-②	AL2M-LK1-②PN02	2	<ul style="list-style-type: none"> Specify a color code in place of ② in the Part No. A: amber G: green R: red W: white Y: yellow
		Square	AL2Q-LK1-②	AL2Q-LK1-②PN02		
		Rectangular	AL2H-LK1-②	AL2H-LK1-②PN02		
	For IP65 illuminated pushbuttons	Round	AL2M-LK2-②	AL2M-LK2-②	1	
		Square	AL2Q-LK2-②	AL2Q-LK2-②		
		Rectangular	AL2H-LK2-②	AL2H-LK2-②		
	For IP65 pilot lights	Round	AL2M-LK3-②	AL2M-LK3-②	1	
		Square	AL2Q-LK3-②	AL2Q-LK3-②		
		Rectangular	AL2H-LK3-②	AL2H-LK3-②		
	For IP40 pushbuttons	Round	AB2M-BK1-①	AB2M-BK1-①PN02	2	<ul style="list-style-type: none"> Specify a color code in place of ① in the Part No. B: black G: green R: red S: blue W: white Y: yellow
		Square	AB2Q-BK1-①	AB2Q-BK1-①PN02		
		Rectangular	AB2H-BK1-①	AB2H-BK1-①PN02		
	For IP65 pushbuttons	Round	AB2M-BK2-①	AB2M-BK2-①	1	
		Square	AB2Q-BK2-①	AB2Q-BK2-①		
		Rectangular	AB2H-BK2-①	AB2H-BK2-①		

ø10 A1 Series Illuminated Pushbuttons & Pilot Lights

Package Quantity: 1

Shape	Operation	Contact	Part No.	② Lens Color Code	LED Lamp
			IP40		Part No., Rated Current (External Resistor Recommended Value)
Round AL1M 	Momentary	SPDT	AL1M-M11②	Specify a color code in place of ② in the Part No. A: amber G: green R: red W: white Y: yellow	A: LAD-SA G: LAD-SG R: LAD-SR W/Y: LAD-SY Rated Current: 20 mA 5V DC: 150Ω, 1/2W 6V DC: 200Ω, 1/2W 12V DC: 510Ω, 1W 24V DC: 1.1 kΩ, 1W
	Maintained	SPDT	AL1M-A11②		
	Pilot Light	—	AL1M-P1②		
Square AL1Q 	Momentary	SPDT	AL1Q-M11②		
	Maintained	SPDT	AL1Q-A11②		
	Pilot Light	—	AL1Q-P1②		
Rectangular AL1H 	Momentary	SPDT	AL1H-M11②		
	Maintained	SPDT	AL1H-A11②		
	Pilot Light	—	AL1H-P1②		

- LED lamps do not have a current-limiting resistor. Connect a current-limiting resistor in series, otherwise LED lamps will be damaged.
- AP1M series pilot lights (round bezel only) with built-in current-limiting resistor are also available.
- Pilot lights are not CCC certified.

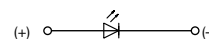

Dimensions

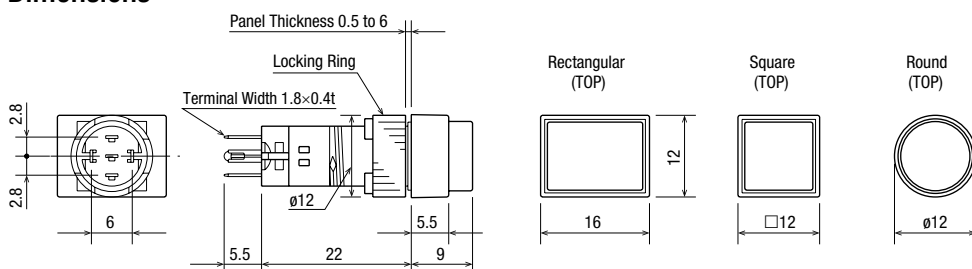

Terminal Arrangement (bottom view)

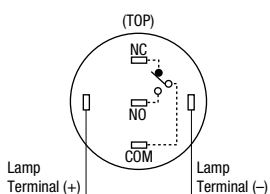

Mounting Hole Layout

Round/Square Units

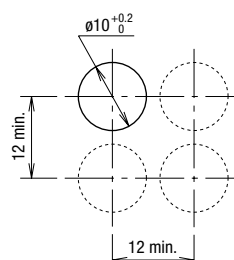

Rectangular Units

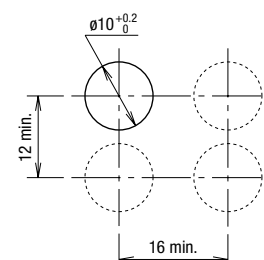

Note: Determine mounting centers to ensure easy operation.

All dimensions in mm.

- APEM
- Switches & Pilot Lights
- Control Boxes
- Emergency Stop Switches
- Enabling Switches
- Safety Products
- Explosion Proof
- Terminal Blocks
- Relays & Sockets
- Circuit Protectors
- Power Supplies
- LED Illumination
- Controllers
- Operator Interfaces
- Sensors
- AUTO-ID

Flush Silhouette

ø16

ø22

ø30

Miniature

Pilot Lights

HW1Z



AP22

A Series

LD6A

ø10 A1 Series Pushbuttons

Package Quantity: 1

Shape	Button Style	Operation	Contact	Part No.	Color Code ①②
				IP40	
Round AB1M 	Button	Momentary	SPDT	AB1M-M1①	B: black G: green R: red S: blue W: white Y: yellow
		Maintained	SPDT	AB1M-A1①	
	Lens	Momentary	SPDT	AB1M-M1L②	A: amber G: green R: red W: white Y: yellow
		Maintained	SPDT	AB1M-A1L②	
Square AB1Q 	Button	Momentary	SPDT	AB1Q-M1①	B: black G: green R: red S: blue W: white Y: yellow
		Maintained	SPDT	AB1Q-A1①	
	Lens	Momentary	SPDT	AB1Q-M1L②	A: amber G: green R: red W: white Y: yellow
		Maintained	SPDT	AB1Q-A1L②	
Rectangular AB1H 	Button	Momentary	SPDT	AB1H-M1①	B: black G: green R: red S: blue W: white Y: yellow
		Maintained	SPDT	AB1H-A1①	
	Lens	Momentary	SPDT	AB1H-M1L②	A: amber G: green R: red W: white Y: yellow
		Maintained	SPDT	AB1H-A1L②	

• Specify a color code in place of ① or ② in the Part No.

Dimensions

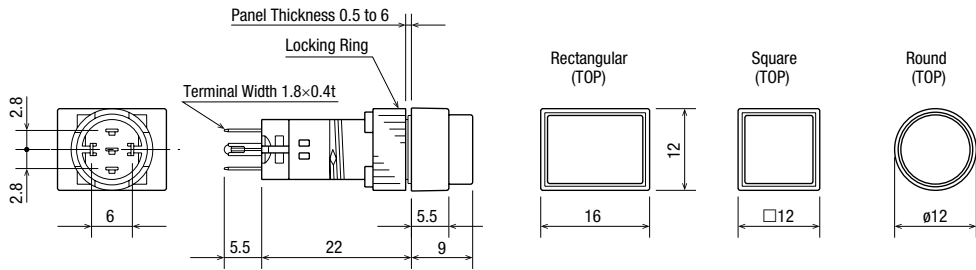

Terminal Arrangement (bottom view)

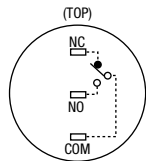

Mounting Hole Layout

Round/Square Units

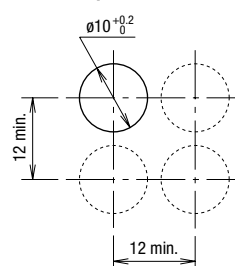

Rectangular Units

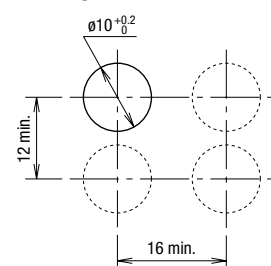





Note: Determine mounting centers to ensure easy operation.

All dimensions in mm.

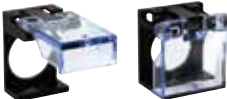
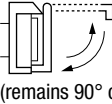
ø10 A1 Series Accessories

All dimensions in mm.

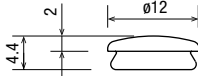
Shape	Material	Part No.	Ordering No.	Package Quantity	Remarks	
Locking Ring Wrench 	Metal (nickel-plated brass)	MT-003	MT-003	1	<ul style="list-style-type: none"> Used to tighten the locking ring when installing the A1 series into a panel. 	
Switch Guard 	90° open	For round/ square unit	AL-K1	AL-K1	1	<ul style="list-style-type: none"> Used to protect pushbuttons from inadvertent operation. See B-389 for dimensions.  (remains 90° open)
		For rectangular unit	AL-KH1	AL-KH1	1	
Socket 	Solder Terminal	AL-C1	AL-C1	1	<ul style="list-style-type: none"> Snaps on the rear of the A1 series. (see B-389 for dimensions) 	
	PC Board Terminal	AL-C1V	AL-C1V	1		
Terminal Cover 	Nylon	AL-V1	AL-V1PN10	10	<ul style="list-style-type: none"> When wiring the terminals, insert the lead wires into the terminal cover holes before soldering. Terminal cover is not attached and must be ordered separately. 	
Mounting Hole Plug 	Nitryl rubber (black)	AL-B1	AL-B1PN05	5	<ul style="list-style-type: none"> Degree of protection: IP65 	

APEM

Switches & Pilot Lights

Control Boxes

Emergency Stop Switches

Enabling Switches

Safety Products

Explosion Proof

Terminal Blocks

Relays & Sockets

Circuit Protectors

Power Supplies

LED Illumination

Controllers

Operator Interfaces

Sensors

AUTO-ID

Flush Silhouette

ø16

ø22

ø30

Miniature

Pilot Lights

HW1Z

AP22

A Series

LD6A

ø10 A1 Series Dimensions

All dimensions in mm.

Switch Guard

For Round/Square Units (AL-K1)

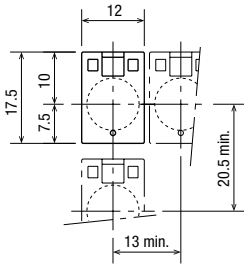

For Rectangular Units (AL-KH1)

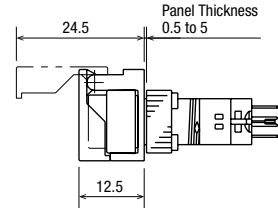
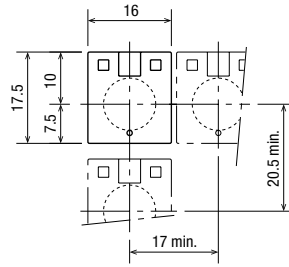

Socket (AL-C1, AL-C1V)

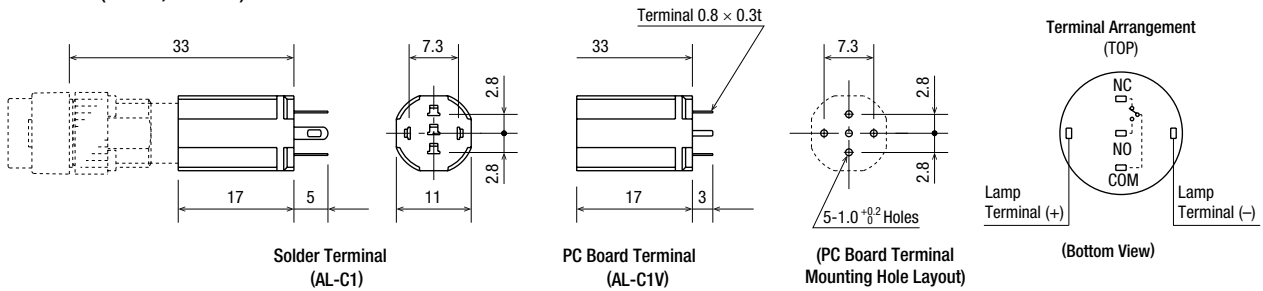

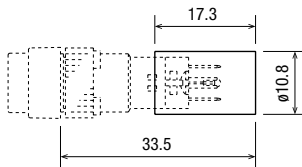

Terminal Cover



Note: When wiring the terminals, insert the lead wires into the terminal cover holes before soldering.



ø10 A1 Series Maintenance Parts

All dimensions in mm.

Shape	Part No.	Ordering No.	Package Quantity	Color Code ①②	
Marking Plate 	Round	AL1M-W	AL1M-WPN05	5	• White
	Square	AL1Q-W	AL1Q-WPN05		
	Rectangular	AL1H-W	AL1H-WPN05		
Lens Unit 	Round	AL1M-LK1-②	AL1M-LK1-②PN02	2	Specify a color code in place of ② in the Part No. A (amber), G (green), R (red) W (white), Y (yellow)
	Square	AL1Q-LK1-②	AL1Q-LK1-②PN02		
	Rectangular	AL1H-LK1-②	AL1H-LK1-②PN02		
Button Unit 	Round	AB1M-BK1-①	AB1M-BK1-①PN02	2	Specify a color code in place of ① in the Part No. B (black), G (green), R (red) S (blue), W (white), Y (yellow)
	Square	AB1Q-BK1-①	AB1Q-BK1-①PN02		
	Rectangular	AB1H-BK1-①	AB1H-BK1-①PN02		

ø8 A8 Series Illuminated Pushbuttons & Pilot Lights

Package Quantity: 1

Shape	Operation	Contact	Part No.	② Lens Color Code	LED Lamp
			IP40		Part No., Rated Current (External Resistor Recommended Value)
Round AL8M 	Momentary	SPDT	AL8M-M11②	Specify a color code in place of ② in the Part No. A: amber G: green R: red W: white Y: yellow	A: LAD-SA G: LAD-SG R: LAD-SR W/Y: LAD-SY Rated Current: 20 mA 5V DC: 150Ω, 1/2W 6V DC: 200Ω, 1/2W 12V DC: 510Ω, 1W 24V DC: 1.1 kΩ, 1W
	Maintained	SPDT	AL8M-A11②		
	Pilot Light	—	AL8M-P1②		
Square AL8Q 	Momentary	SPDT	AL8Q-M11②		
	Maintained	SPDT	AL8Q-A11②		
	Pilot Light	—	AL8Q-P1②		
Rectangular AL8H 	Momentary	SPDT	AL8H-M11②		
	Maintained	SPDT	AL8H-A11②		
	Pilot Light	—	AL8H-P1②		

- LED lamps do not have a current-limiting resistor. Connect a current-limiting resistor in series, otherwise LED lamps will be damaged.
- AP8M series pilot lights (round bezel only) with built-in current-limiting resistor are also available.
- Pilot lights are not CCC certified.

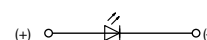

Dimensions

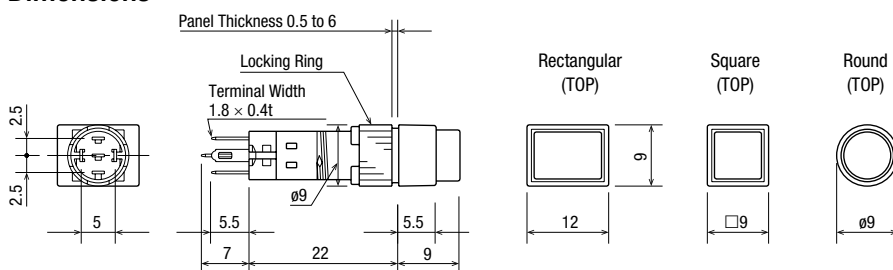

Terminal Arrangement

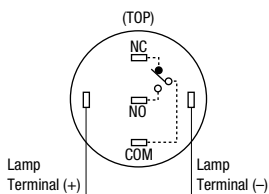

Mounting Hole Layout

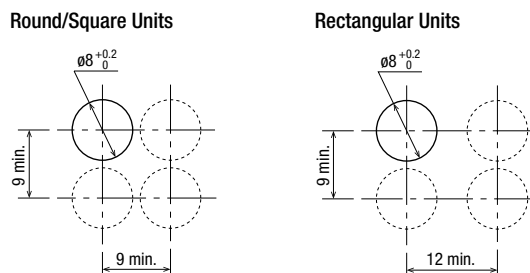

Note: Determine mounting centers to ensure easy operation.

All dimensions in mm.

- APEM
- Switches & Pilot Lights
- Control Boxes
- Emergency Stop Switches
- Enabling Switches
- Safety Products
- Explosion Proof
- Terminal Blocks
- Relays & Sockets
- Circuit Protectors
- Power Supplies
- LED Illumination
- Controllers
- Operator Interfaces
- Sensors
- AUTO-ID

Flush Silhouette

ø16

ø22

ø30

Miniature

Pilot Lights

HW1Z



AP22

A Series

LD6A

ø8 A8 Series Pushbuttons

Package Quantity: 1

Shape	Button Style	Operation	Contact	Part No.	Color Code ①②
				IP40	
Round AB8M 	Button	Momentary	SPDT	AB8M-M1①	B: black G: green R: red S: blue W: white Y: yellow
		Maintained	SPDT	AB8M-A1①	
	Lens	Momentary	SPDT	AB8M-M1L②	A: amber G: green R: red W: white Y: yellow
		Maintained	SPDT	AB8M-A1L②	
Square AB8Q 	Button	Momentary	SPDT	AB8Q-M1①	B: black G: green R: red S: blue W: white Y: yellow
		Maintained	SPDT	AB8Q-A1①	
	Lens	Momentary	SPDT	AB8Q-M1L②	A: amber G: green R: red W: white Y: yellow
		Maintained	SPDT	AB8Q-A1L②	
Rectangular AB8H 	Button	Momentary	SPDT	AB8H-M1①	B: black G: green R: red S: blue W: white Y: yellow
		Maintained	SPDT	AB8H-A1①	
	Lens	Momentary	SPDT	AB8H-M1L②	A: amber G: green R: red W: white Y: yellow
		Maintained	SPDT	AB8H-A1L②	

- Specify a color code in place of ① or ② in the Part No.
- Lens style buttons can be used with marking plate and film.

Dimensions

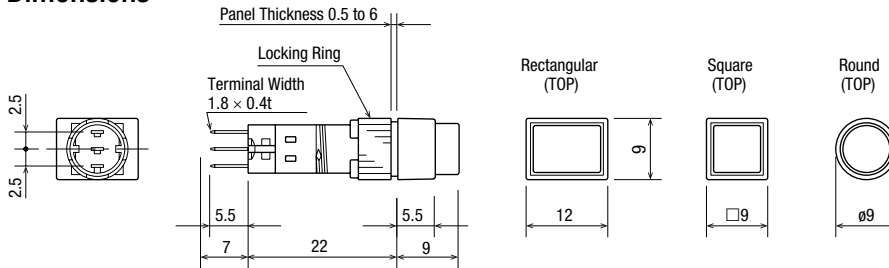

Terminal Arrangement (bottom view)

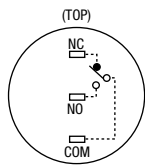

Mounting Hole Layout

Round/Square Units

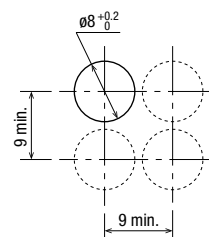

Rectangular Units

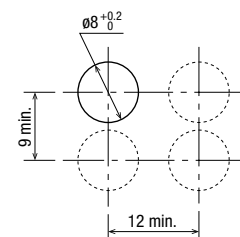







Note: Determine mounting centers to ensure easy operation.

All dimensions in mm.

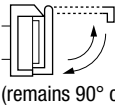
ø8 A8 Series Accessories

All dimensions in mm.

Shape	Material	Part No.	Ordering Part No.	Package Quantity	Remarks	
Locking Ring Wrench 	Metal (nickel-plated brass)	MT-004	MT-004	1	<ul style="list-style-type: none"> Used to tighten the locking ring when installing the A8 series into a panel. 	
Switch Guard 	90° open	For round/square Unit	AL-K8	AL-K8	1	<ul style="list-style-type: none"> Used to protect pushbuttons from inadvertent operation. See B-393 for dimensions.  (remains 90° open)
		For rectangular unit	AL-KH8	AL-KH8	1	
Socket 	Solder Terminal	AL-C8	AL-C8	1	<ul style="list-style-type: none"> Snaps on the rear of the A8 series. (see B-393 for dimensions) 	
	PC Board Terminal	AL-C8V	AL-C8V	1		
Terminal Cover 	Nylon	AL-V8	AL-V8PN10	10	<ul style="list-style-type: none"> When wiring the terminals, insert the lead wires into the terminal cover holes before soldering. Terminal cover is not attached and must be ordered separately. 	
Mounting Hole Plug 	Nitryl rubber (black)	AL-B8	AL-B8PN05	5	<ul style="list-style-type: none"> Degree of protection: IP65 	

APEM

Switches & Pilot Lights

Control Boxes

Emergency Stop Switches

Enabling Switches

Safety Products

Explosion Proof

Terminal Blocks

Relays & Sockets

Circuit Protectors

Power Supplies

LED Illumination

Controllers

Operator Interfaces

Sensors

AUTO-ID

Flush Silhouette

ø16

ø22

ø30

Miniature

Pilot Lights

HW1Z

AP22

A Series

LD6A



ø8 A8 Series Dimensions

All dimensions in mm.

Switch Guard

For Round/Square Units (AL-K8)

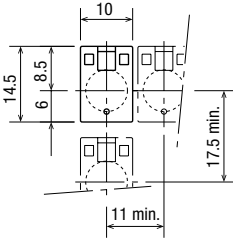

For Rectangular Units (AL-KH8)

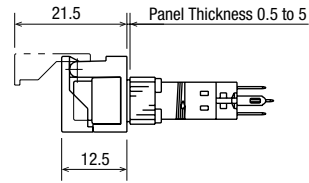
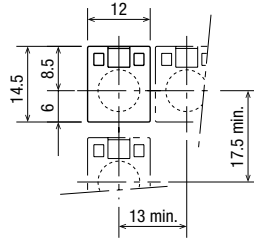

Socket

(AL-C8, AL-C8V)

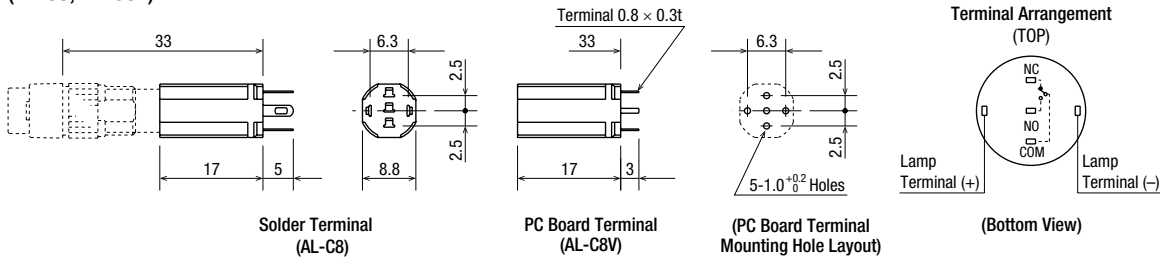
Solder Terminal
(AL-C8)PC Board Terminal
(AL-C8V)(PC Board Terminal
Mounting Hole Layout)

(Bottom View)

Terminal Cover

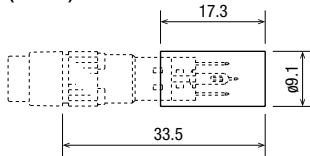

(AL-V8)



Note: When wiring the terminals, insert the lead wires into the terminal cover holes before soldering.

ø8 A8 Series Maintenance Parts

All dimensions in mm.

Shape	Part No.	Ordering Part No.	Package Quantity	Color Code ①②	
Marking Plate 	Round	AL8M-W	AL8M-WPN05	5	• White
	Square	AL8Q-W	AL8Q-WPN05		
	Rectangular	AL8H-W	AL8H-WPN05		
Lens Unit 	Round	AL8M-LK1-②	AL8M-LK1-②PN02	2	Specify a color code in place of ② in the Part No. A (amber), G (green), R (red) W (white), Y (yellow)
	Square	AL8Q-LK1-②	AL8Q-LK1-②PN02		
	Rectangular	AL8H-LK1-②	AL8H-LK1-②PN02		
Button Unit 	Round	AB8M-BK1-①	AB8M-BK1-①PN02	2	Specify a color code in place of ① in the Part No. B (black), G (green), R (red) S (blue), W (white), Y (yellow)
	Square	AB8Q-BK1-①	AB8Q-BK1-①PN02		
	Rectangular	AB8H-BK1-①	AB8H-BK1-①PN02		

A2/A1/A8 Series Accessories

All dimensions in mm.

When ordering, specify the Ordering No.

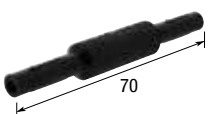
Shape	Material	Part No.	Ordering Part No.	Package Quantity	Remarks
	Stainless Steel	MT-101	MT-101	1	• Used to remove the lens and button.
	Rubber	OR-66	OR-66	1	• Used to remove and install the LED lamps.

A2/A1/A8 Series Maintenance Parts

All dimensions in mm.

When ordering, specify the Ordering No.

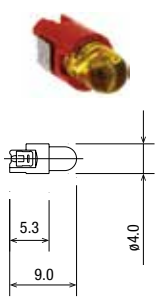
Shape	Part No.	Ordering Part No.	Package Quantity	Remarks			
	Illumination color: red	LAD-SR	LAD-SR	1	Red	LED color: clear red	
		LAD-SRPN10	LAD-SRPN10	10			
	Illumination color: green	LAD-SG	LAD-SG	LAD-SG	1	Green	LED color: yellow diffused
		LAD-SGPN10	LAD-SGPN10	10			
	Illumination color: amber	LAD-SA	LAD-SA	LAD-SA	1	Amber	LED color: amber clear
		LAD-SAPN10	LAD-SAPN10	10			
	Illumination color: yellow	LAD-SY	LAD-SY	LAD-SY	1	White/ Yellow	LED color: yellow clear
		LAD-SYPN10	LAD-SYPN10	10			

- APEM
- Switches & Pilot Lights
- Control Boxes
- Emergency Stop Switches
- Enabling Switches
- Safety Products
- Explosion Proof
- Terminal Blocks
- Relays & Sockets
- Circuit Protectors
- Power Supplies
- LED Illumination
- Controllers
- Operator Interfaces
- Sensors
- AUTO-ID
- Flush Silhouette
- ø16
- ø22
- ø30
- Miniature
- Pilot Lights
- HW1Z
- AP22
- A Series
- LD6A

Safety Precautions

- Turn off the power to A series before starting installation, removal, wiring, maintenance, and inspection of the units. Failure to turn power off may cause electrical shocks or fire hazard.
- To avoid burning your hand, use the lamp holder tool when replacing lamps.
- For wiring, use wires of a proper gauge to meet the voltage and current requirements. Failure to tighten terminal screws may cause overheating and create a fire hazard.

Operating Instructions

Replacement of Lens and Marking Plate

Removal

Remove the lens assembly (color lens, marking plate, lens holder, and spring) by holding the color lens recesses with the Lens Removal Tool (MT-101) and pulling it out. Remove the marking plate by disengaging the latches between the color lens and lens holder. The marking plate must be engraved on the front side as shown below.

• A2 Series

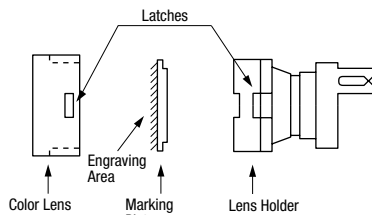

• A8, A1 Series

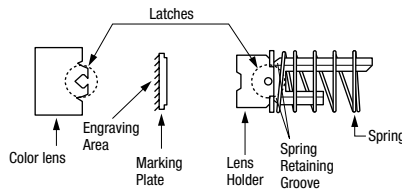

Note: Make sure that the spring is inserted in the correct direction. The base of spring must fit the groove in the holder.

Installation

Place the marking plate on the lens holder in the correct direction, and press the color lens onto the lens holder to engage the latches. Put the spring on the lens holder and insert the lens holder into the housing in the correct direction.

Installing Non-illuminated Button

Non-illuminated pushbuttons contain the same marking plate as illuminated units. Be sure to install the marking plate when replacing the button.

Replacing the LED Lamp

Removal

Use the lamp holder tool (OR-66) to remove lamps. Do not use pliers.

Installation

Use the lamp holder tool (OR-66) to install lamps. Note the correct side of the tool for removal or installation.

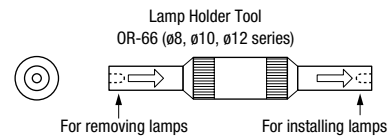

Panel Mounting

When mounting the units into a panel, use the optional locking ring wrench (MT-002/-003/-004) to tighten the locking ring. Do not use pliers. Tightening torque must not exceed 0.78 N·m (A8, A1 series : 0.29 N·m). Excessive tightening will damage the locking ring.

Wiring

Solder the terminal at 350°C within 3 seconds using a 60W soldering iron. Sn-Ag-Cu is recommended when using lead-free solder. When soldering, do not touch the unit with the soldering iron. Also ensure that no tensile force is applied to the terminal. Do not bend the terminal or apply excessive force to the terminal. Use non-corrosive rosin flux.

Installing the Socket

Install the socket on the unit with the TOP markings on the unit and the socket placed in the same direction.

Operating Voltage of LED Lamps

The operating voltage is measured at complete DC. When using a pulsating voltage such as a full-wave rectification voltage, keep peak currents within the forward current I_f . Peak currents exceeding the I_f may shorten the LED lamp life.

Operating Instructions

Marking

For A series illuminated pushbuttons, legends and symbols can be engraved on the built-in marking plates, or printed film can be inserted under the lens.

Marking Plate & Engraving Area

A2 Series

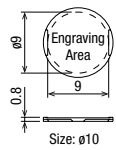
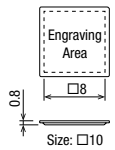
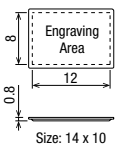
Lens	Round	Square	Rectangular
Built-in Marking Plate			
	<ul style="list-style-type: none"> Engraving must be made on the engraving area less than 0.5mm deep. The marking plate is made of white acrylic resin. 		

A1 Series

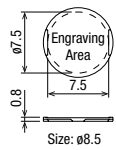
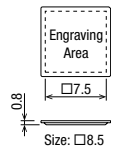
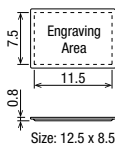
Lens	Round	Square	Rectangular
Built-in Marking Plate			
	<ul style="list-style-type: none"> Engraving must be made on the engraving area less than 0.5mm deep. The marking plate is made of white acrylic resin. 		

A8 Series

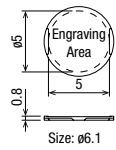
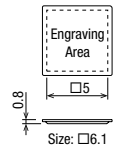
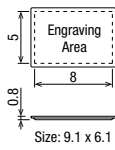
Lens	Round	Square	Rectangular
Built-in Marking Plate			
	<ul style="list-style-type: none"> Engraving must be made on the engraving area less than 0.5mm deep. The marking plate is made of white acrylic resin. 		

Other Notes

Close Proximity Mounting

When mounting pilot lights or illuminated pushbuttons collectively or lighting them continuously, heat may cause the ambient temperature to rise above the rated operating temperature. When the mounting panel is not made of metal or when the units are mounted in an enclosed panel, provide for ventilation or lower the operating voltage.

Replacement of Buttons (Illuminated/Non-illuminated)

Do not replace buttons of maintained action units while the button is in the locked position. Replacing the button in the locked position may damage the internal mechanism. Be sure to release the button before replacing.

Operating and Storage Environment

1. Make sure that the operating/storage temperature and humidity are within the ratings.
2. Do not use enclosed type units in an environment subject to oil, water or dust accumulation.

Microswitch Contacts

Do not connect NO and NC contacts of the microswitch to different voltages or different power sources to prevent a dead short-circuit.

IP65 Units (A2 series only)

IP65 units are evaluated by conventional cutting and cooling oils, and can not be used with some special oils. Contact IDEC for resistance against special oils.

APEM

Switches & Pilot Lights

Control Boxes

Emergency Stop Switches

Enabling Switches

Safety Products

Explosion Proof

Terminal Blocks

Relays & Sockets

Circuit Protectors

Power Supplies

LED Illumination

Controllers

Operator Interfaces

Sensors

AUTO-ID

Flush Silhouette

ø16

ø22

ø30

Miniature

Pilot Lights

HW1Z

AP22

A Series

LD6A